

SOT-23-6 Plastic-Encapsulate MOSFETS

SI8205S

SI8205S Dual N-Channel MOSFET

$V_{(BR)DSS}$	$R_{DS(on)MAX}$	I_D Max
20V	0.025 Ω @ 4.5V	5.0A
	0.033 Ω @ 2.5V	

FEATURE

- TrenchFET Power MOSFET
- Excellent $R_{DS(on)}$
- Low Gate Charge
- High Power and Current Handling Capability
- Surface Mount Package

APPLICATION

- Battery Protection
- Load Switch
- Power Management

SOT-23-6

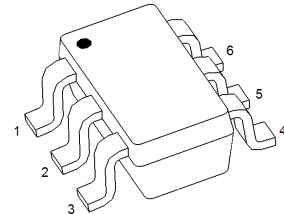

Equivalent Circuit

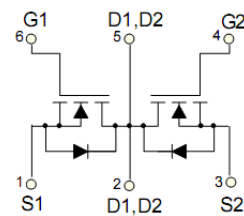

MARKING

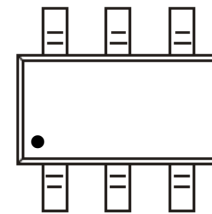

Y :year code W :week code

ABSOLUTE MAXIMUM RATINGS ($T_a=25^\circ\text{C}$ unless otherwise noted)

Parameter	Symbol	Value	Unit
Drain-Source Voltage	V_{DS}	20	V
Gate-Source Voltage	V_{GS}	± 8	V
Continuous Drain Current	I_D	5	A
Pulsed Drain Current (note 1)	I_{DM}	15	A
Thermal Resistance from Junction to Ambient (note 2)	$R_{\theta JA}$	100	$^\circ\text{C}/\text{W}$
Junction Temperature	T_J	150	$^\circ\text{C}$
Storage Temperature	T_{STG}	-55~+150	$^\circ\text{C}$
Lead Temperature for Soldering Purposes(1/8" from case for 10 s)	T_L	260	$^\circ\text{C}$

SOT-23-6 Plastic-Encapsulate MOSFETS

SI8205S

MOSFET ELECTRICAL CHARACTERISTICS

T_a =25 °C unless otherwise specified

Parameter	Symbol	Test Condition	Min	Typ	Max	Unit
STATIC CHARACTERISTICS						
Drain-source breakdown voltage	V _{(BR)DSS}	V _{GS} = 0V, I _D =250μA	20			V
Zero gate voltage drain current	I _{DSS}	V _{DS} =16V, V _{GS} = 0V			1	μA
Gate-body leakage current	I _{GSS}	V _{GS} =±8V, V _{DS} = 0V			±100	nA
Gate threshold voltage (note 3)	V _{GS(th)}	V _{DS} =V _{GS} , I _D =250μA	0.5		1.0	V
Drain-source on-resistance (note 3)	R _{DS(on)}	V _{GS} =4.5V, I _D =5A		23	25	mΩ
		V _{GS} =2.5V, I _D =4A		26	33	mΩ
Forward transconductance (note 3)	g _{FS}	V _{DS} =5V, I _D =5A		10		S
Diode forward voltage (note 3)	V _{SD}	I _S =3.50A, V _{GS} = 0V			1.2	V
DYNAMIC CHARACTERISTICS (note4)						
Input Capacitance	C _{iss}	V _{DS} =8V, V _{GS} =0V, f =1MHz		800		pF
Output Capacitance	C _{oss}			155		pF
Reverse Transfer Capacitance	C _{rss}			125		pF
SWITCHING CHARACTERISTICS (note 4)						
Turn-on delay time	t _{d(on)}	V _{DD} =10V, V _{GS} =4V, I _D =1A, R _{GEN} =10Ω		18		ns
Turn-on rise time	t _r			4.8		ns
Turn-off delay time	t _{d(off)}			43.5		ns
Turn-off fall time	t _f			20		ns
Total Gate Charge	Q _g	V _{DS} =10V, V _{GS} =4.5V, I _D =4A		11		nC
Gate-Source Charge	Q _{gs}			2.2		nC
Gate-Drain Charge	Q _{gd}			2.5		nC

Notes :

- 1.Repetitive rating: Pulse width limited by maximum junction temperature
- 2.Surface Mounted on FR4 board, t ≤ 10 sec.
3. Pulse test : Pulse width ≤ 300μs, duty cycle ≤ 2%.
4. Guaranteed by design, not subject to production.

SOT-23-6 Plastic-Encapsulate MOSFETS

SI8205S

Typical Electrical and Thermal Characteristics

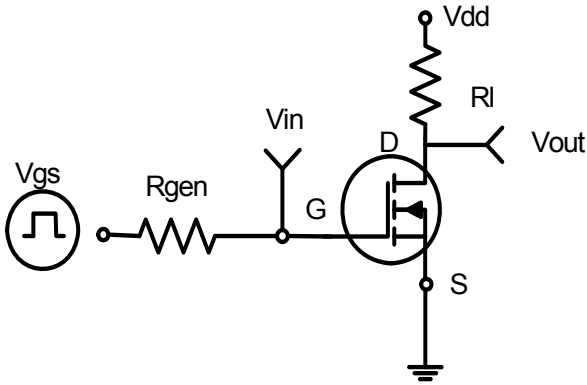

Figure 1: Switching Test Circuit

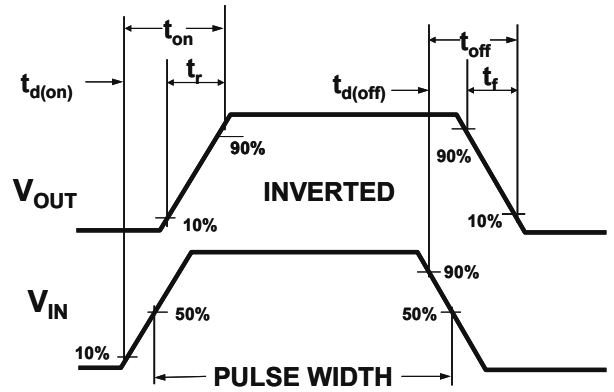

Figure 2: Switching Waveforms

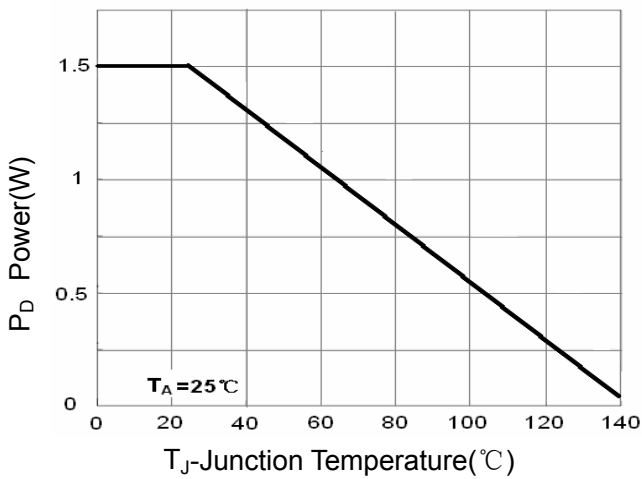

Figure 3 Power Dissipation

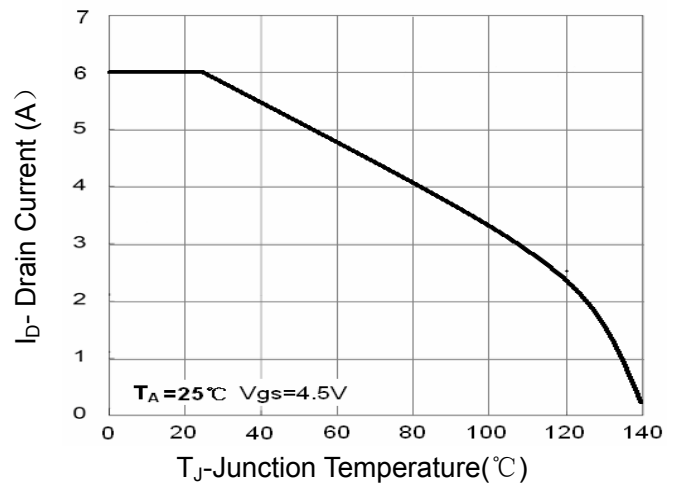

Figure 4 Drain Current

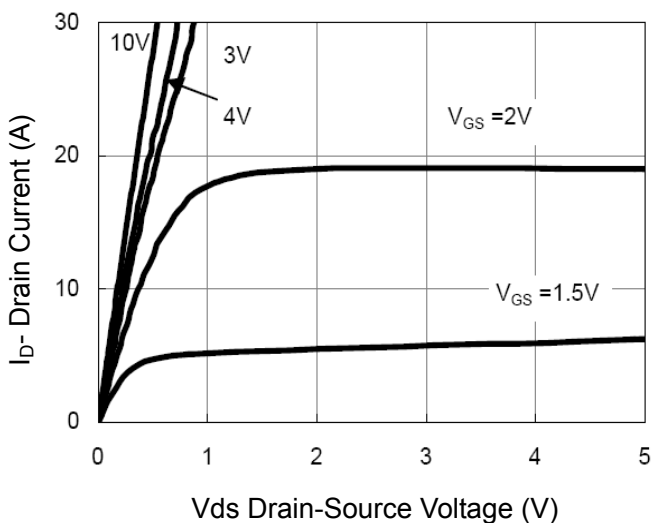

Figure 5 Output Characteristics

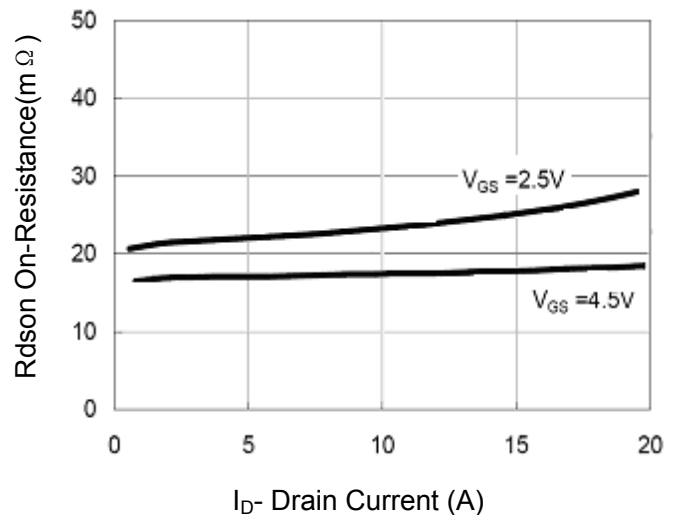

Figure 6 Drain-Source On-Resistance

SOT-23-6L Plastic-Encapsulate MOSFETS

SI8205S

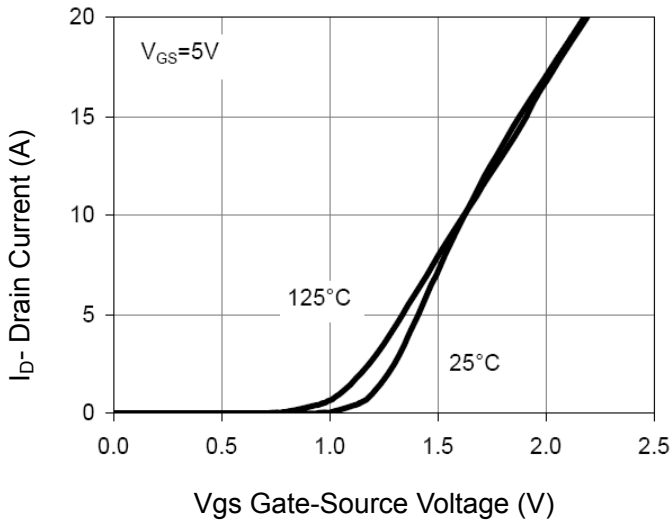

Figure 7 Transfer Characteristics

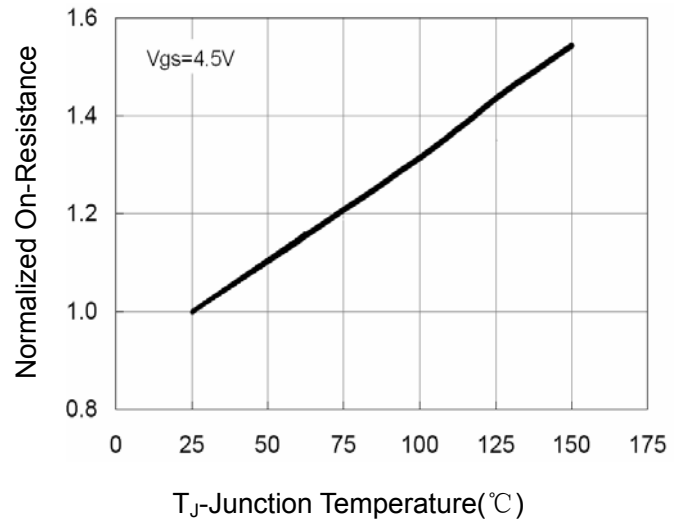

Figure 8 Drain-Source On-Resistance

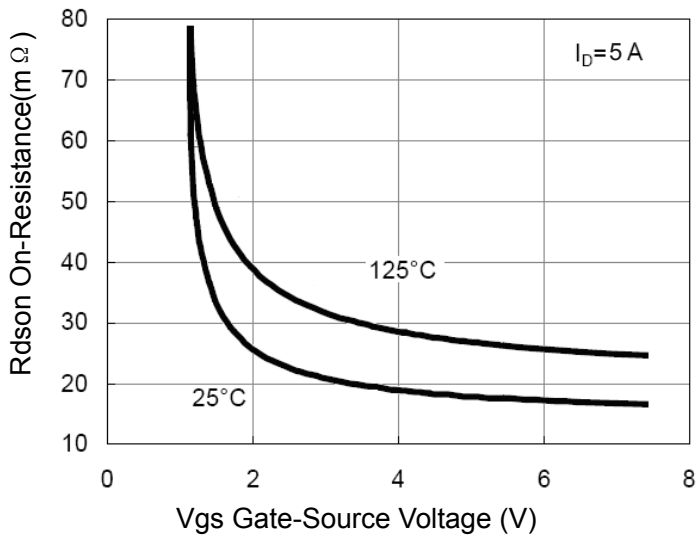

Figure 9 Rdson vs Vgs

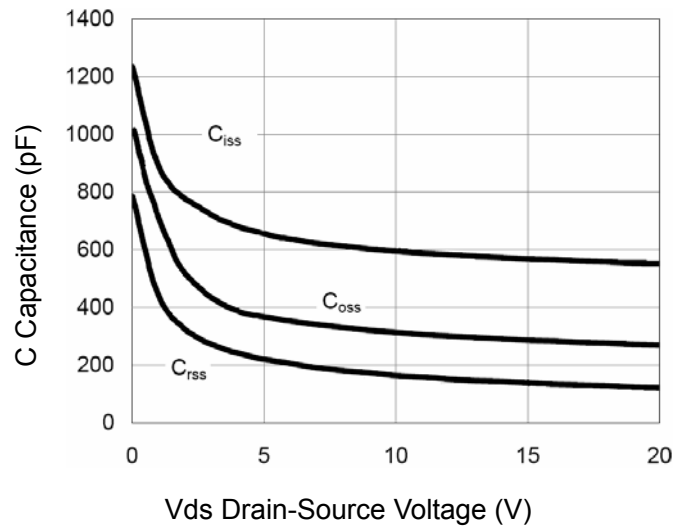

Figure 10 Capacitance vs Vds

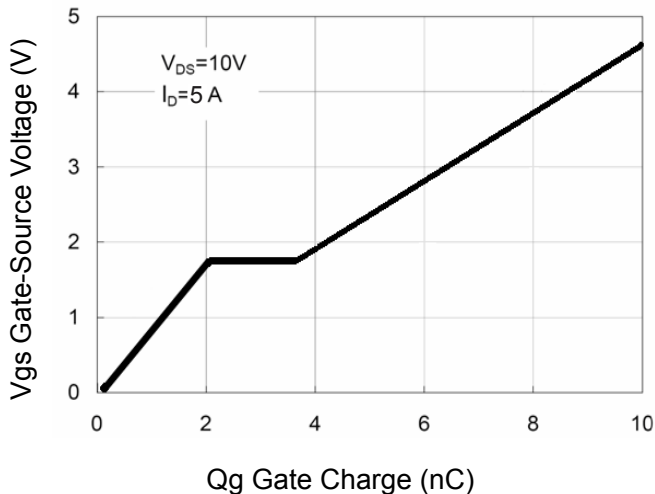

Figure 11 Gate Charge

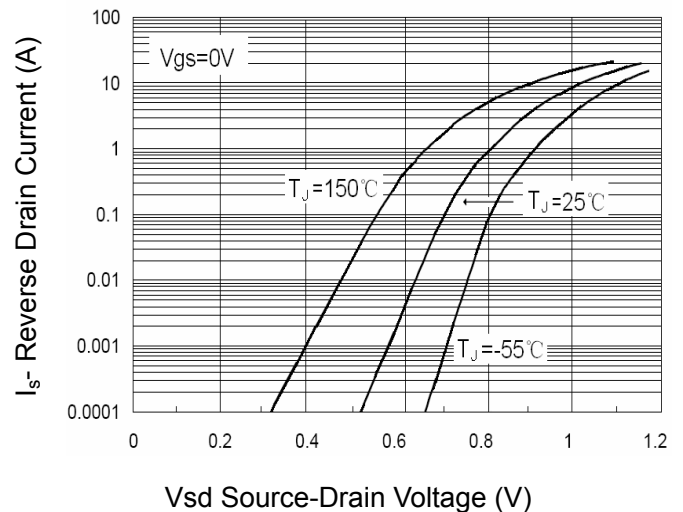

Figure 12 Source- Drain Diode Forward

SOT-23-6 Plastic-Encapsulate MOSFETS

SI8205S

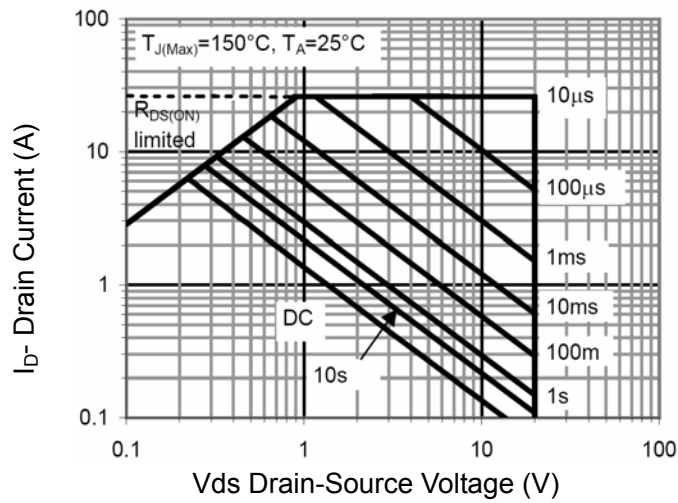

Figure 13 Safe Operation Area

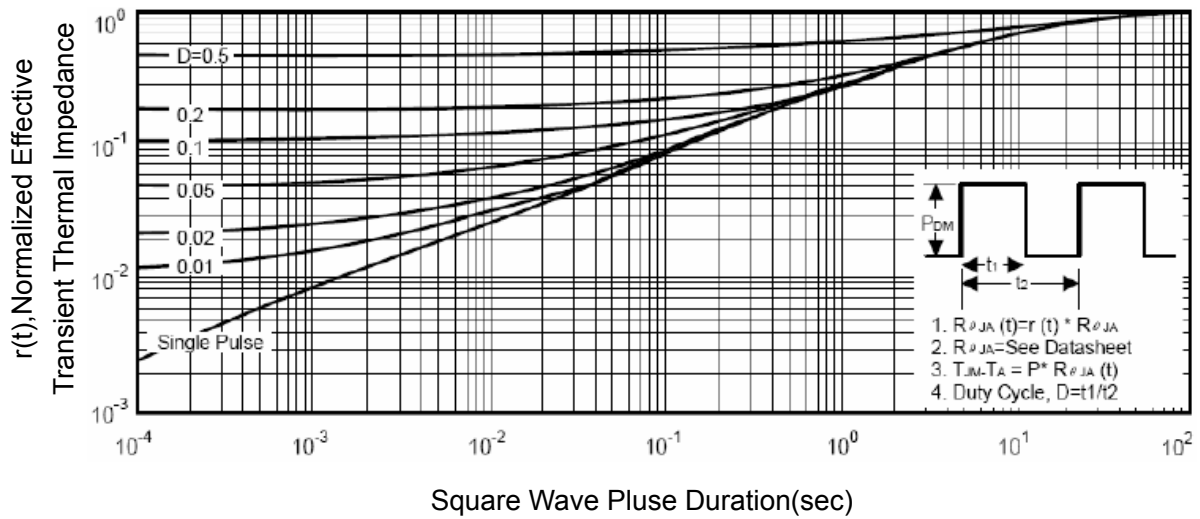
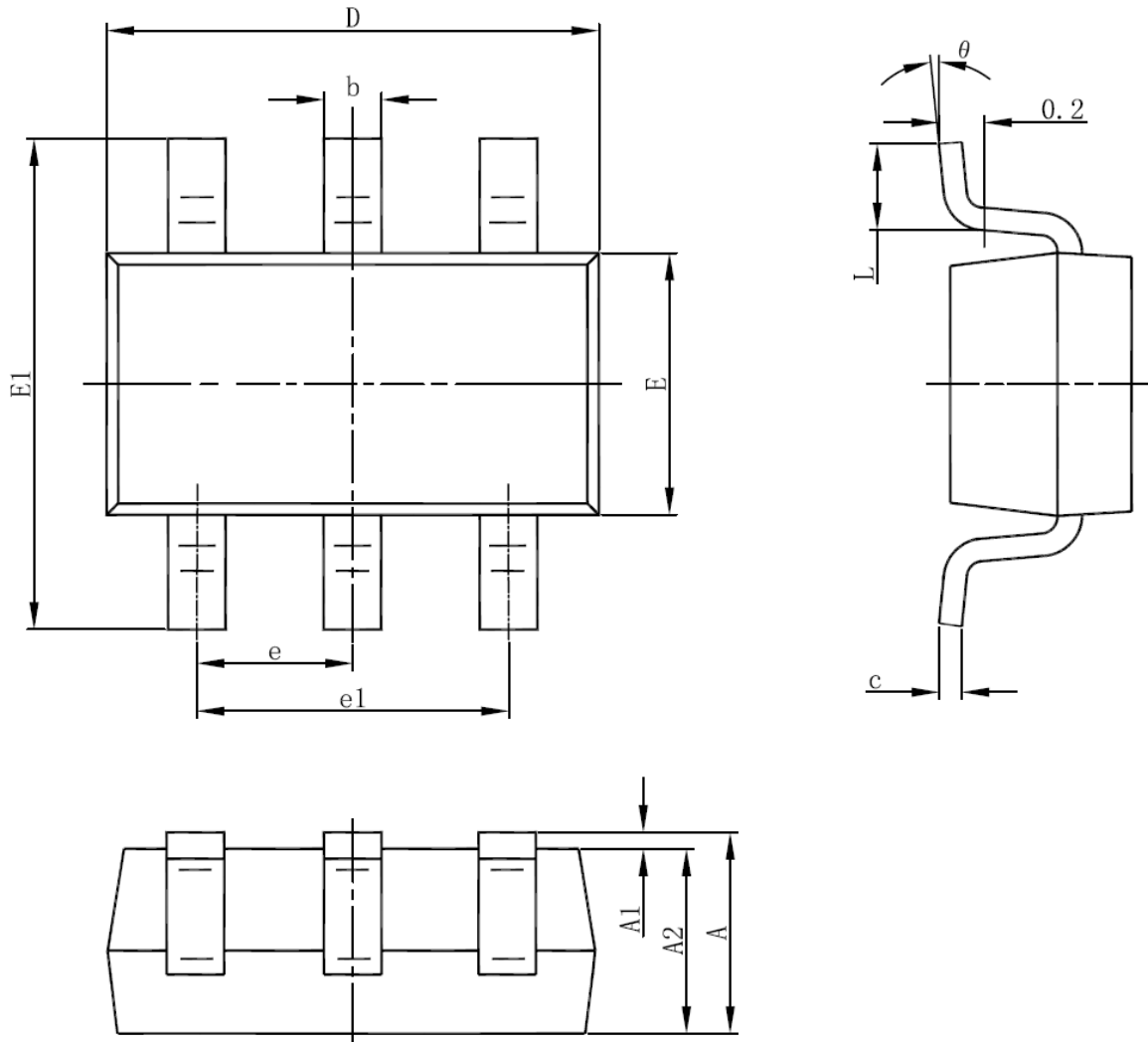

Figure 14 Normalized Maximum Transient Thermal Impedance

SOT-23-6 Plastic-Encapsulate MOSFETS

SI8205S

SOT23-6 Package Information



Symbol	Dimensions In Millimeters		Dimensions In Inches	
	Min	Max	Min	Max
A	1.050	1.250	0.041	0.049
A1	0.000	0.100	0.000	0.004
A2	1.050	1.150	0.041	0.045
b	0.300	0.500	0.012	0.020
c	0.100	0.200	0.004	0.008
D	2.820	3.020	0.111	0.119
E	1.500	1.700	0.059	0.067
E1	2.650	2.950	0.104	0.116
e	0.950(BSC)		0.037(BSC)	
e1	1.800	2.000	0.071	0.079
L	0.300	0.600	0.012	0.024
θ	0°	8°	0°	8°